

Mission Success

Ensign-Bickford Aerospace & Defense Company (EBAD) is dedicated to supporting our customers in the aerospace and defense industry through on-time delivery of innovative products that exceed expectations and assure mission success.

8030 Series Battery Cell Bypass Switch

EBAD, the global leader in non-pyrotechnic Hold Down & Release Mechanisms (HDRM) for the spacecraft market, brings this same highly reliable technology to battery protection applications with our complete line of Battery Cell Bypass Switches. Battery Cell Bypass Switches provide critical protection to battery assemblies in the event that one battery cell suffers an anomaly.

Principle of Operation

The NEA® Battery Cell Bypass Switch is an electrically initiated, one-shot switch that bypasses and isolates failed battery cells. The switch consists of a spring-loaded plunger with highly conductive metal plated electrical contacts arranged in a Single-Pole, Double-Throw configuration providing Make-Before-Break functionality after the switch is actuated and the plunger moves in the housing. The plunger is restrained using the same patented split-spool and bridge wire technology used in our Hold Down & Release Mechanisms.

Typically, switches are placed in series between battery cells and, when activated, bypass and isolate failed cells from the battery assembly. The design and construction of the bypass switch assure that there is no contact bounce during high dynamic loads seen during satellite launch. When activated, there are two features that ensure reliable system operation; Make-Before-Break functionality assures there is no voltage dropout during switching and low switch contact resistance assures high continuous current carrying capability, ensuring reliable system operation for the duration of your mission.

Several NEA® switch models come with built-in Zener diodes that are used to autonomously redirect current through the actuation fuse wire when a failed cell is detected. This autonomous operation device can save considerable cost associated with battery cell sensing and switch actuation circuitry.

Key Features

- Available in non-autonomous and autonomous configurations
- Switch circuit can carry up to 250A of continuous current
- Single-Pole, Double-Throw (SPDT) Make-Before-Break power switch
- High reliability and long service life
- Low power switch resistance
- Lightweight
- Extended operating temperature range
- Can be operated with pyrotechnic initiation circuitry
- Range safety friendly
- Space-rated materials
- Factory refurbishment

8030 Series Technical Specifications

Parameter	Capability
Continuous Current Ratings	250 A
Switch Resistance	<200 μΩ @ 250 A
Fuse Wire Resistance	0.5 to 1.6 Ω @ 25°C
Minimum Actuation Current¹	1.2 A
Nominal Actuation Current	4 Amps for 25 ms
No-Fire Current² (continuity)	250 mA
Actuation Time³	<50 ms
Make Before Break Duration	<1 ms
Qualification Temperature Range⁴	-55°C to +85°C
Mass⁵	130 g (4.59 oz)

Notes:

- ¹ Actuation can be achieved using a range of current, the value in the table is the value used for qualifying this device.
- ² No-fire current for 5 minutes or less as ambient temperature, consult an EBAD applications engineer for other no-fire current requirements.
- ³ Actuation time is dependent on actuation current, contact applications engineering for more specific information on actuation time as a function of current.
- ⁴ The values presented for qualification temperature range are not a measure of the limits of the device.
- ⁵ Mass is representative and varies slightly with different specific part numbers within the series but does not include harnessing and lead wires.

Model 8030 Battery Cell Bypass Switch Mechanical Interface Drawing

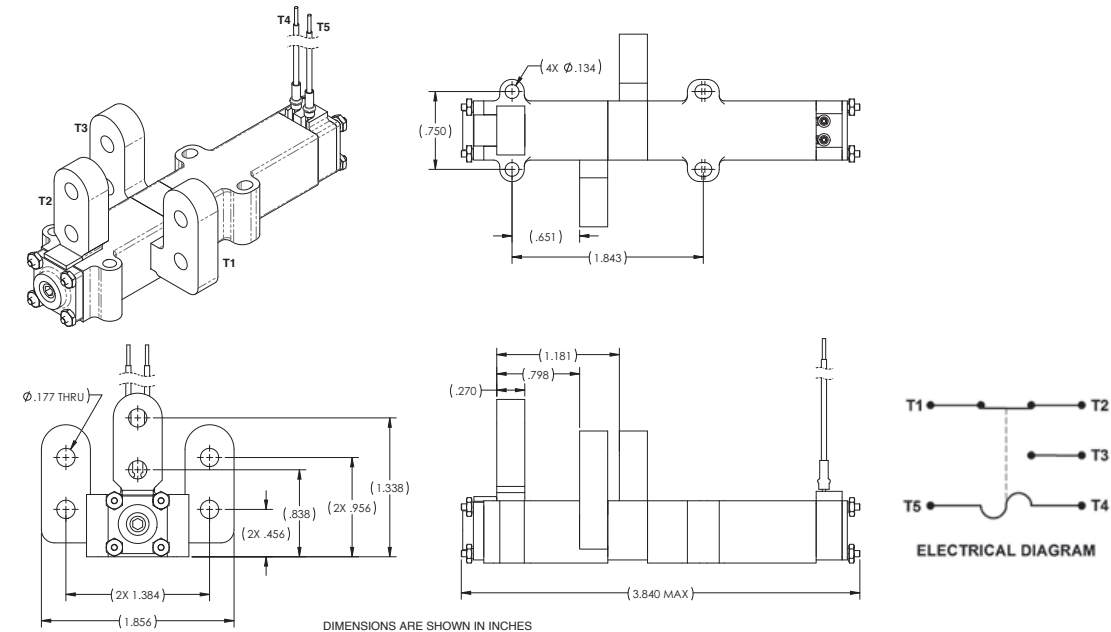

Note: Model 8030 Battery Cell Bypass Switch as an example. Other models available with alternate mounting feet, terminal configurations and optional zener diodes for autonomous operation.